

SPECIFICATIONS

- › SOLID METAL CONSTRUCTION
- › FOR USE ON SLIDING DOORS AND PANELS
- › FITS 2-3/8" (60 mm) BORE HOLE
- › MOUNTING SCREWS INCLUDED

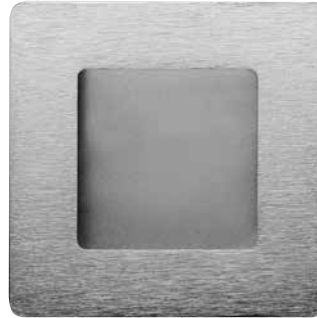
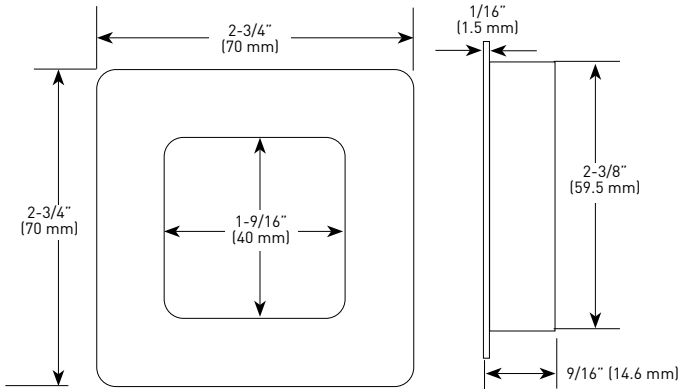

SQUARE DOOR PULLS POLY BAGGED WITH UPC

SATIN NICKEL
15

MATTE BLACK
19

POLISHED CHROME
26

SATIN CHROME
26D

CASE
QTY.

20-L3000SN

20-L3000BLK

25-L3000PC

20-L3000SC

50

SPECIFICATIONS

- › STEEL CONSTRUCTION
- › FOR USE ON SLIDING DOORS AND PANELS
- › PRESSURE FIT
- › FITS 2-1/8" (54 mm) BORE HOLE

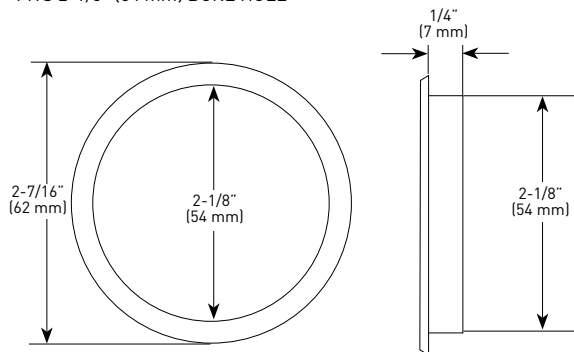

ROUND DOOR PULLS POLY BAGGED WITH UPC

SATIN NICKEL
15

MATTE BLACK
19

POLISHED CHROME
26

SATIN CHROME
26D

CASE
QTY.

20-L2900SN

20-L2900BLK

25-L2900PC

20-L2900SC

150

MEASUREMENTS SUBJECT TO A 3% VARIANCE

MEASUREMENTS ARE FOR REFERENCE ONLY. TAYMOR RESERVES THE RIGHT TO CHANGE THE PRODUCT SPECS WITHOUT NOTICE. FOR PRODUCT WARRANTY, PLEASE VISIT TAYMOR WEBSITE FOR DETAILS