

SPECIFICATIONS

- UNIVERSAL 6-IN-IN LATCH: DRIVE IN, SQUARE MORTISE AND RADIUS CORNER WITH ADJUSTABLE BACKSET: 2-3/8" (60 mm) - 2-3/4" (70 mm)
- STANDARD BORE HOLES: 2-1/8" (54 mm)
- FITS STANDARD DOOR THICKNESS: 1-3/8" (35 mm) - 1-3/4" (45 mm)
- FULL LIP RADIUS CORNER STRIKE WITH ADJUSTABLE TAB STANDARD: 1-3/4" x 2-1/4" (45 mm x 57 mm)
- EASY ACCESS EXPOSED DUAL SCREWS (ONE SIDE)
- PUSH BUTTON AUTO-RELEASE ON PRIVACY FUNCTION
- TURN BUTTON AUTO-RELEASE ON ENTRY FUNCTION
- NON-FIRE RATED



GRADE
3
ANSI GRADE 3



LIFETIME MECHANICAL & FINISH WARRANTY

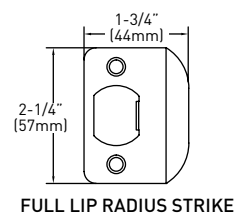
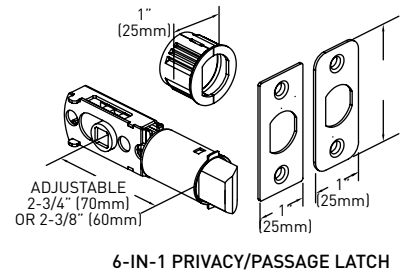
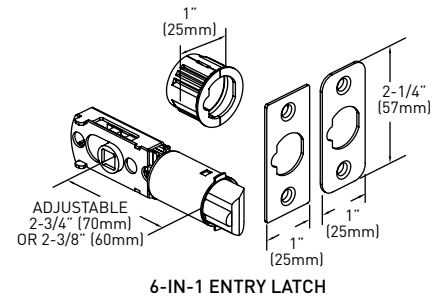
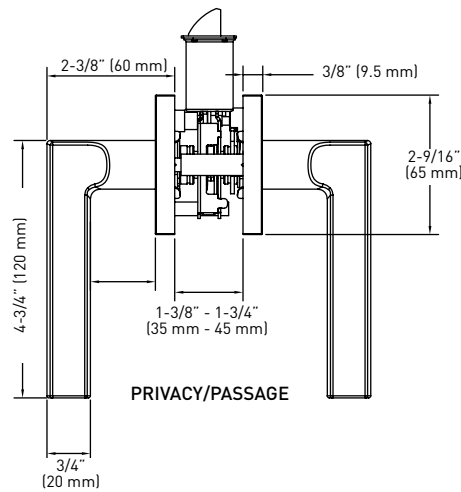
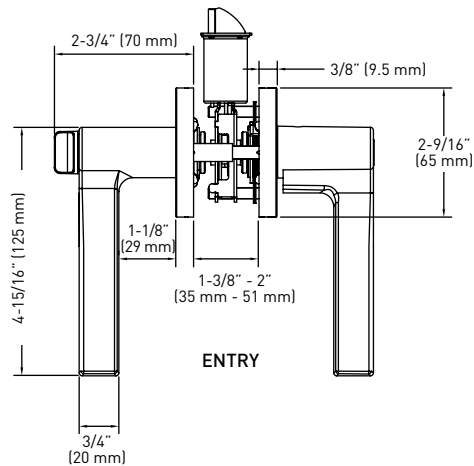
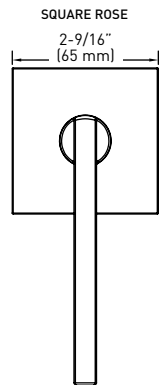
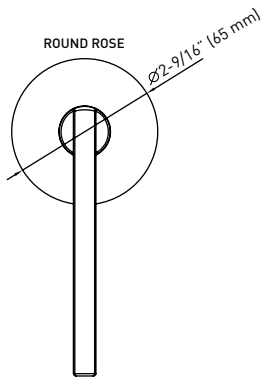

MEASUREMENTS SUBJECT TO A 3% VARIANCE

MEASUREMENTS ARE FOR REFERENCE ONLY. TAYMOR RESERVES THE RIGHT TO CHANGE THE PRODUCT SPECS WITHOUT NOTICE. FOR PRODUCT WARRANTY, PLEASE VISIT TAYMOR WEBSITE FOR DETAILS

ROUND ROSE

BUILDER PACK	ENTRY	PRIVACY	PASSAGE	DUMMY	CASE QTY.
SATIN NICKEL 15	33-D009164SN	33-D009124SN	33-D009134SN	33-914SN	20
MATTE BLACK 19	33-D009164BLK	33-D009124BLK	33-D009134BLK	33-914BLK	20
POLISHED CHROME 26	33-D009164PC	33-D009124PC	33-D009134PC	33-914PC	20

RETAIL PACK

SATIN NICKEL 15	34-FV009164SN	34-FV009124SN	34-FV009134SN	-	4
MATTE BLACK 19	34-FV009164BLK	34-FV009124BLK	34-FV009134BLK	-	4

SQUARE ROSE

BUILDER PACK	ENTRY	PRIVACY	PASSAGE	DUMMY	CASE QTY.
SATIN NICKEL 15	33-D009264SN	33-D009224SN	33-D009234SN	33-924SN	20
MATTE BLACK 19	33-D009264BLK	33-D009224BLK	33-D009234BLK	33-924BLK	20
POLISHED CHROME 26	33-D009264PC	33-D009224PC	33-D009234PC	33-924PC	20

RETAIL PACK

SATIN NICKEL 15	34-FV009264SN	34-FV009224SN	34-FV009234SN	-	4
MATTE BLACK 19	34-FV009264BLK	34-FV009224BLK	34-FV009234BLK	-	4

