

### SPECIFICATIONS

- UNIVERSAL 6-IN-IN LATCH: DRIVE IN, SQUARE MORTISE AND RADIUS CORNER WITH ADJUSTABLE BACKSET: 2-3/8" (60 mm) - 2-3/4" (70 mm)
- STANDARD BORE HOLES: 2-1/8" (54 mm)
- FITS STANDARD DOOR THICKNESS: 1-3/8" (35 mm) - 1-3/4" (45 mm)
- FULL LIP RADIUS CORNER STRIKE WITH ADJUSTABLE TAB STANDARD: 1-3/4" x 2-1/4" (45 mm x 57 mm)
- EASY ACCESS EXPOSED DUAL SCREWS (ONE SIDE)
- PUSH BUTTON AUTO-RELEASE ON PRIVACY FUNCTION
- TURN BUTTON AUTO-RELEASE ON ENTRY FUNCTION
- NON-FIRE RATED

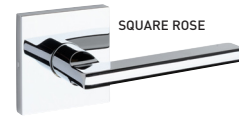

GRADE  
**3**  
ANSI GRADE 3

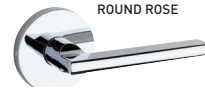

LIFETIME MECHANICAL & 5 YEAR FINISH WARRANTY

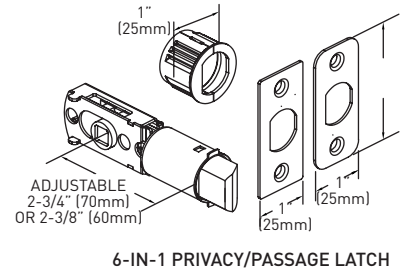
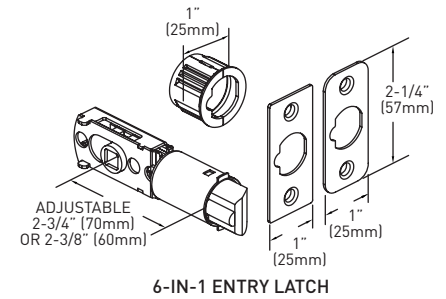
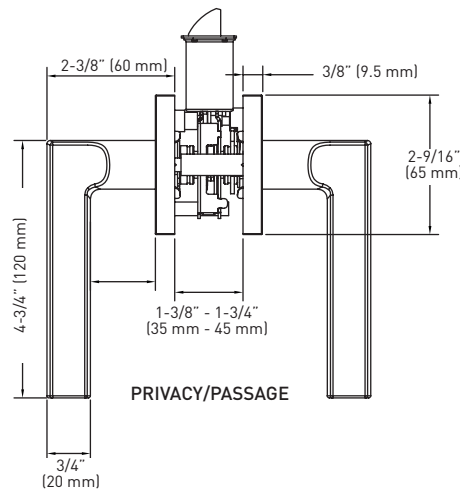
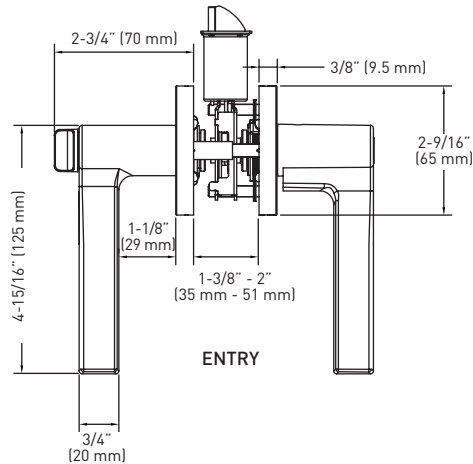
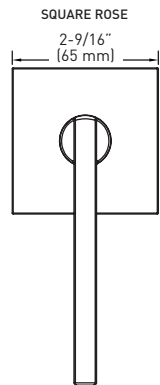
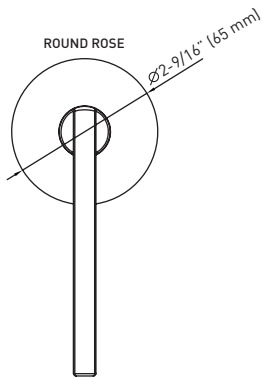

6-IN-1 PRIVACY/PASSAGE LATCH

FULL LIP RADIUS STRIKE

MEASUREMENTS SUBJECT TO A 3% VARIANCE

MEASUREMENTS ARE FOR REFERENCE ONLY. TAYMOR RESERVES THE RIGHT TO CHANGE THE PRODUCT SPECS WITHOUT NOTICE. FOR PRODUCT WARRANTY, PLEASE VISIT TAYMOR WEBSITE FOR DETAILS

### ROUND ROSE

BUILDER PACK	ENTRY	PRIVACY	PASSAGE	DUMMY	CASE QTY.
SATIN NICKEL 15	33-D009164SN	33-D009124SN	33-D009134SN	33-914SN	20
MATTE BLACK 19	33-D009164BLK	33-D009124BLK	33-D009134BLK	33-914BLK	20
POLISHED CHROME 26	33-D009164PC	33-D009124PC	33-D009134PC	33-914PC	20

### RETAIL PACK

SATIN NICKEL 15	34-FV009164SN	34-FV009124SN	34-FV009134SN	-	4
MATTE BLACK 19	34-FV009164BLK	34-FV009124BLK	34-FV009134BLK	-	4

### SQUARE ROSE

BUILDER PACK	ENTRY	PRIVACY	PASSAGE	DUMMY	CASE QTY.
SATIN NICKEL 15	33-D009264SN	33-D009224SN	33-D009234SN	33-924SN	20
MATTE BLACK 19	33-D009264BLK	33-D009224BLK	33-D009234BLK	33-924BLK	20
POLISHED CHROME 26	33-D009264PC	33-D009224PC	33-D009234PC	33-924PC	20

### RETAIL PACK

SATIN NICKEL 15	34-FV009264SN	34-FV009224SN	34-FV009234SN	-	4
MATTE BLACK 19	34-FV009264BLK	34-FV009224BLK	34-FV009234BLK	-	4

